

INSTRUCTION MANUAL

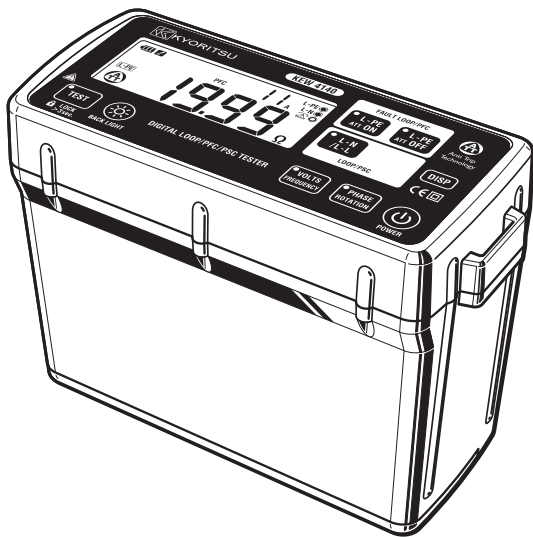

DIGITAL LOOP/PFC/PSC TESTER

KEW 4140



**KYORITSU ELECTRICAL
INSTRUMENTS WORKS, LTD.**

CONTENTS

1. Safe Testing	1
2. Instruments Layout	3
3. Accessories	6
4. Features	7
5. Specification	8
5.1 Measurement Specification	8
5.2 Operating Error	9
5.3 General Specification	10
5.4 Applied Standards	10
6. Preparation for Measurement	11
7. LOOP/PSC/PFC Test	12
7.1 Principles of Measurement of Fault Loop Impedance and PFC	12
7.2 Principles of Measurement of Line Impedance and PSC	16
7.3 Operating Instructions for LOOP and PSC/PFC	17
7.3.1 Initial Checks	17
7.3.2 Measurement Of LOOP And PSC/PFC	18
7.3.3 Contents on Sub Display	18
8. Phase Rotation Test	22
9. Volts	23
10. Back Light	23
11. Auto-Test	23
12. Battery Replacement	24
13. Servicing	25
14. Case and Strap Assembly	26

The KEW4140 incorporates Anti Trip Technology (ATT) which electronically bypasses RCDs when performing loop impedance tests. This saves time and money by not having to take the RCD out of the circuit during testing and is a safer procedure to follow. With the ATT function enabled, a test of 15mA or less is applied between line & earth.

It enables loop impedance measurements without tripping RCDs rated at 30mA and above.



Please read this instruction manual carefully before using this equipment.



1. Safe Testing

Electricity is dangerous and can cause injury and death. Always treat it with the greatest of respect and care. If you are not quite sure how to proceed, stop and take advice from a qualified person. This instruction manual contains warning and safety rules which must be observed by the user to ensure safe operation of the instrument and retain it in safe condition. Therefore, read through these operating instructions before using the instrument.

IMPORTANT:

- 1 This instrument must only be used by a competent and trained person and operated in strict accordance with the instructions. KYORITSU will not accept liability for any damage or injury caused by misuse or non-compliance with the instructions or with the safety procedures.
- 2 It is essential to read and to understand the safety rules contained in these instructions. They must always be observed when using the instrument.

The symbol  indicated on the instrument means that the user must refer to the related sections in the manual for safe operation of the instrument. Be sure to carefully read instructions following each symbol  in this manual.

-  **DANGER** is reserved for conditions and actions that are likely to cause serious or fatal injury.
-  **WARNING** is reserved for conditions and actions that can cause serious or fatal injury.
-  **CAUTION** is reserved for conditions and actions that can cause a minor injury or instrument damage.

⚠ DANGER

● This instrument is designed to work in distribution systems where the line to earth has a maximum voltage of 300V 50/60Hz and for some ranges where line to line has a maximum voltage of 500V 50/60Hz.

Be sure to use it within this rated voltage.

- When conducting tests do not touch any exposed metalwork associated with the installation. Such metalwork may become live for the duration of the test.
- For safety reasons only use accessories (test leads, probes, cases, etc) designed to be used with this instrument and recommended by KYORITSU. The use of other accessories is prohibited as they are unlikely to have the correct safety features.
- When testing, always be sure to keep your fingers behind the finger guards on the test leads.

⚠ WARNING

● Never open the instrument case (except for battery replacement and in this case disconnect all leads first) because dangerous voltages are present. Only fully trained and competent electrical engineers should open the case. If a fault develops, return the instrument to your distributor for inspection and repair.

● If the overheat symbol  appears in the display disconnect the instrument from the mains supply and allow to cool down.

● If abnormal conditions of any sort are noted (such as a faulty display, unexpected readings, broken case, cracked test leads, etc) do not use the tester and return it to your distributor for repair.

● Never attempt to use the instrument if the instrument or your hand is wet.

⚠ CAUTION

● During testing it is possible that there may be a momentary degradation of the reading due to the presence of excessive transients or discharges on the electrical system under test. Should this be observed, the test must be repeated to obtain a correct reading. If in doubt, contact your distributor.

● Use a damp cloth and detergent for cleaning the instrument. Do not use abrasives or solvents.

2. Instrument Layout

1. Front View

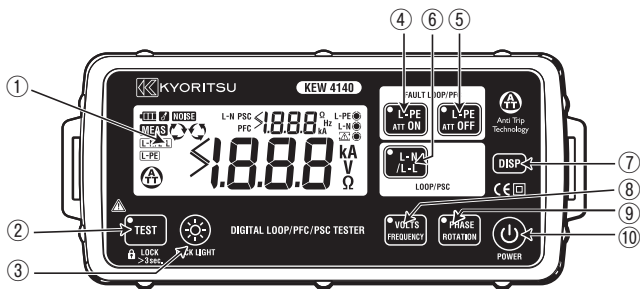

Fig.2-1

Name	Operation
① Display(LCD)	--
② Test Switch	Start measurements.
③ Back Light Switch	Switches on/off the Back light of the Display(LCD)
④ L-PE ATT ON Switch	Select "L-PE ATT ON" function
⑤ L-PE ATT OFF Switch	Select "L-PE ATT OFF" function
⑥ L-N/L-L Switch	Select "L-N/L-L" Function
⑦ DISP Switch	Change the contents on Sub Display
⑧ VOLTS/ FREQUENCY Switch	Select "VOLTS/FREQUENCY" function
⑨ PHASE ROTATION Switch	Select "PHASE ROTATION" function
⑩ Power Switch	Power Switch (Press down for at least 1 sec.)

2. Input Terminal

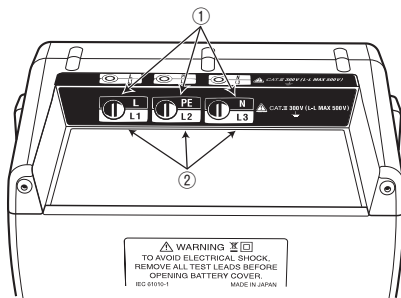

Fig.2-2

① Terminal Names for : LOOP, VOLTS	L : Line
	PE : Protective Earth
	N : Neutral (for LOOP)
② Terminal Name for PHASE ROTATION	L1 : Line1
	L2 : Line2
	L3 : Line3

3. LCD

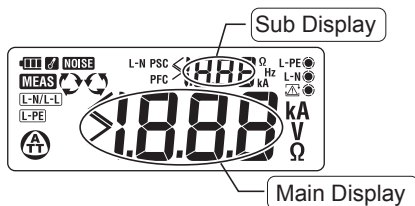













Fig.2-3

List of Display Message

	Battery symbol	
>	Displayed when the measured values exceed the displayable range. (over-range) e.g. The display shows ">1999Ω" at a LOOP test when a test result exceeds 1999Ω.	
	Displayed when "L-PE ATT ON" function is selected to indicate ATT is on.	
	The LCD indicates "L-PE" when "L-PE ATT ON" or "ATT OFF" is selected and "L-N/L-L" when "L-N/L-L" is selected.	
L-N PSC PFC	Indicating what the values displayed on the Sub Display.	
	Temperature monitor for internal resistance, available at Loop, PSC/PFC function. Further measurements are suspended until the "  " symbol disappears.	
	Measuring symbol (LOOP function)	
L-N>20Ω	Alert: Presence of 20Ω or more between Line- Neutral at ATT ON measurement	
	Caution : Presence of noise in the circuit under test during ATT measurement. ATT function should be disabled to continue measurements.	
nEHv	Caution: Presence of high voltage between NEUTRAL - EARTH during ATT measurement. ATT function should be disabled to continue measurements.	
	Wiring check for LOOP function	
	Displayed at PHASE ROTATION check Correct phase sequence : displayed  mark. Reversed phase sequence : displayed  mark.	
no	PHASE ROTATION	Appears to indicate wrong connection at Phase Rotation check.
	LOOP	When on the LOOP function, supply may have been interrupted.

3. Accessories

1. Main Test Lead (Model 7218)

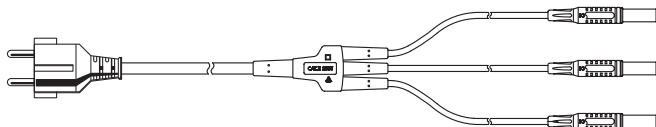

Fig.3-1

2. Distribution Board Test Lead (Model 7246)

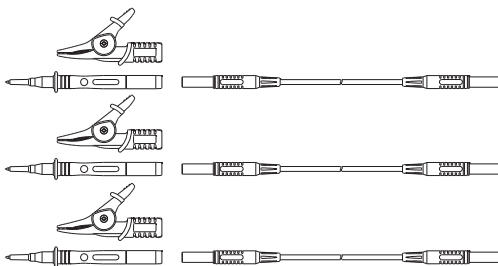

Fig.3-2

- 3. Soft Case Model 9156...x1
- 4. Strap Belt Model 9155...x1
- 5. Battery...x6

4. Features

The KEW4140 LOOP/PFC/PSC tester performs three function in one instrument.

- 1 Loop impedance tester
- 2 Voltage tester
- 3 Phase rotation tester

The KEW4140 have the following features:

- | | |
|-----------------------------|--|
| ATT (Anti Trip Technology) | ATT enables a measurement without tripping the RCDs with the rated residual current of 30mA or more. |
| Wiring check | Three Wiring symbols indicate if the wiring of the circuit under test is correct. |
| Over temperature protection | Detects overheating of the internal resistor displaying a warning symbol (🔥) and automatically halting further measurements. |
| Auto power off | Automatically switches the instrument off after a period of approximately 10 minutes.
The Auto power off mode can only be cancelled by switching the instrument on again. |
| Back Light | Powered off automatically when 2 min pass after the last operation. |
| SUB Display | PFC, PSC and L-N LOOP resistance values are also measured at LOOP L-PE test and displayed on the Sub Display. |

5. Specification

5.1 Measurement Specification

Loop Impedance

Function (Operating Voltage)	Rated Voltage		Range (Auto-Ranging)	Nominal Test Current at 0Ω External Loop: Magnitude/Duration (* 1)	Accuracy
	Guaranteed Voltage Range				
L-PE ATT OFF (100~280 V) (45~65 Hz)	230V(50/60Hz)		L-PE LOOP: 20Ω: 0.00-19.99Ω 200Ω: 20.0-199.9Ω 2000Ω: 200-1999Ω	L-PE: 20Ω: 6A/20ms 200Ω: 2.3A/20ms 2000Ω: 15mA/250ms	±(3%rdg+4dgt) (* 2)
	230 V (+10%/-15%) (50/60 Hz)±1%		PFC/PSC: 2000A: 0-1999A 20kA: 2.00-19.99kA	L-N: 6A/20ms	
ATT ON (100~280 V) (45~65 Hz)	230V(50/60Hz)		L-PE LOOP: 20Ω: 0.00-19.99Ω 200Ω: 20.0-199.9Ω 2000Ω: 200-1999Ω	L-N: 6A/60ms N-PE: 10mA /approx. 5s	±(3%rdg+6dgt) (* 2)
	230 V (+10%/-15%) (50/60 Hz)±1%		PFC/PSC: 2000A: 0-1999 A 20kA: 2.00-19.99 kA (L-N<20Ω)		
L-N/L-L (100~500 V) (45~65 Hz)	L-N: 230V(50/60Hz) L-L: 400V(50/60Hz)		L-N/L-L LOOP: 20Ω: 0.00-19.99Ω	20Ω: 6A/20ms	L-N: ±(3%rdg+4dgt) L-L: ±(3%rdg+8dgt) (* 3)
	L-N: 230 V (+10%/-15%) L-L: 400 V (+10%/-15%) (50/60 Hz)±1%		PSC: 2000A: 0-1999 A 20kA: 2.00-19.99 kA		



* 1: at 230V

* 2: Accuracy of L-N LOOP displayed on the Sub Display is synchronized with the one at L-N/L-L function.

PSC/PFC Accuracy is derived from measured loop impedance specification and measured voltage specification.

* 3: PSC Accuracy is derived from measured loop impedance specification and measured voltage specification.

PHASE ROTATION

Rated Voltage	Remarks
50~500V	Correct phase sequence : displayed "1.2.3" and  mark
45~65Hz	Reversed phase sequence : displayed "3.2.1" and  mark

Volts

Range	Display Range	Guaranteed Voltage Range	Accuracy
500V	Volt : 0 ~ 525V Frequency : 40.0 ~ 70.0Hz	25 ~ 500Vrms 45 ~ 65Hz	Volt : $\pm(2\%rdg+4dgt)$ Frequency : $\pm(0.5\%rdg+2dgt)$

Possible number of tests with fresh alkaline batteries.

LOOP/PFC/PSC : Approx. 3000 times min (ATT)

VOLT/PHASE ROTATION : Approx. 100H.

5.2 Operating error

Loop Impedance (EN61557-3)

FUNCTION	Operating range compliant with EN61557-3 operating error	Maximum percentage operating error
L-PE	0.40~1999Ω	±30%
L-N/L-L	0.40~19.99Ω	

The influencing variations used for calculating the operating error are denoted as follows;

Temperature : 0 °C and 35 °C

Phase angle : At a phase angle 0° to 18°

System frequency : 49.5Hz to 50.5Hz

System voltage : 230V+10%-15%

Supply voltage : 6.8V to 10.35V

Harmonics : 5% of 3rd harmonic at 0° phase angle
5% of 5th harmonic at 180° phase angle
5% of 7th harmonic at 0° phase angle

D.C quantity : 0.5% of the nominal voltage



5.3 General specification

Instrument dimensions	84 X 184 X 133mm
Instrument weight:-	860g (including batteries.)
Reference conditions	Specifications are based on the following conditions except where otherwise stated:- <ol style="list-style-type: none">1. Ambient temperature: 23±5°C:2. Relative humidity 45% to 75%3. Position: horizontal4. AC power source 230V, 50Hz5. DC power source: 9.0 V6. Altitude up to 2000m, Indoor use
Battery type	Six 1.5V AA batteries Use of alkaline batteries (LR6) is recommended.
Operating temperature and humidity.	-10 to +50°C, relative humidity 85% or less, no condensation
Storage temperature and humidity	-20 to +60°C, relative humidity 75% or less, no condensation

5.4 Applied standards

Instrument operating Standard	IEC/EN61557-1,3,7,10
Safety standard	IEC/EN 61010-1 CATIII (300V) -Instrument IEC/EN 61010-031 CATII (250V)-Test Lead Model7218 CATIII (600V)-Test Lead 7246
Protection degree	IEC 60529 IP54
EMC	EN 61326

This manual and product may use the following symbols adopted from International Safety Standards;

CAT.III	Measurement category" CAT III" applies to;Primary electrical circuits of the equipment Connected directly to the distribution panel, and feeders from the distribution panel to outlets.
	Equipment protected throughout by DOUBLE INSULATION or REINFORCED INSULATION;
	Caution (refer to accompanying documents)
	Earth Ground

6. Preparation for Measurement

Check of Battery voltage

- (1) See “12. Battery replacement” and install batteries in KEW4140.
- (2) Press the Power switch on KEW4140 for at least 1 sec to power on the instrument.

* Power switch is activated only when the switch is pressed for 1 sec or more.

Press the switch for at least 1 sec to power off the instrument.

- (3) Power on KEW4140 and check the Battery symbol displayed at the upper left on the LCD. When the displayed battery level is lowest (▣), the installed batteries will be exhausted soon. Replace the batteries with reference to “12. Battery replacement” to continue further tests.

When the Battery symbol is empty (▣), battery level is lower than the lower limit of the working voltage. In this case, accuracies of the measured values aren't assured. Replace the batteries with new ones.

The empty Battery symbol (▣) is displayed and warning buzzer sounds for 2 sec when powering on the instrument with exhausted batteries.

Batteries to be used

Use of alkaline batteries is recommended. Battery level may not be recognized properly when alkaline batteries aren't used.

7. LOOP/ PSC/PFC Test

7.1 Principles of measurement of fault loop impedance and PFC

If an electrical installation is protected by over-current protective devices including circuit breakers or fuses, the earth loop impedance should be measured.

In the event of a fault the earth fault loop impedance should be low enough (and the prospective fault current high enough) to allow automatic disconnection of the electrical supply by the circuit protection device within a prescribed time interval. Every circuit must be tested to ensure that the earth fault loop impedance value does not exceed that specified or appropriate for the over-current protective device installed in the circuit. The KEW4140 takes a current from the supply and measures the difference between the unloaded and loaded supply voltages. From this difference it is possible to calculate the loop resistance.

TT System

For a TT system the earth fault loop impedance is the sum of the following impedances;

- Impedance of the power transformer secondary winding.
- Impedance of the phase conductor resistance from the power transformer to the location of the fault.
- The impedance of the protective conductor from the fault location to the earth system.
- Resistance of the local earth system (R).
- Resistance of the power transformer earth system (R_0).

The figure below shows (dotted line) the Fault loop impedance for TT systems.

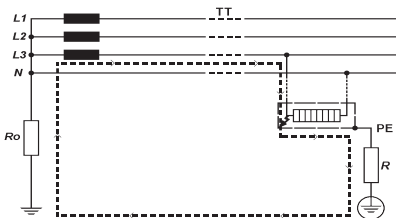

Fig.7-1

According to the International Standard IEC 60364, for TT systems the characteristics of the protective device and the circuit resistance shall fulfill the following requirements:

$R_a \times I_a \leq 50V$ Where:

R_a is the sum of the resistances in Ω of the local earth system and the protective conductor for the exposed conductive parts.

50 is the maximum safety touch voltage limit (it can be 25V in particular cases like construction sites, agricultural premises, etc.).

I_a is the current causing the automatic disconnection of the protective device within the maximum disconnecting times required by IEC 60364-41:

- 200 ms for final circuits not exceeding 32A (at 230 / 400V AC)
- 1000 ms for distribution circuits and circuits over 32A (at 230 / 400V AC)

The compliance with the above rules shall be verified by:

- 1) Measurement of the resistance R_a of the local earth system by Loop tester or Earth tester.
- 2) Verification of the characteristics and/or the effectiveness of the RCD associated protective device.

Generally in TT systems, RCDs shall be used as protective device and in this case, I_a is the rated residual operating current $I_{\Delta n}$. For instance in a TT system protected by a RCD the max R_a values are:

Rated residual operating current $I_{\Delta n}$	30	100	300	500	1000 (mA)
R_a (with touch voltage of 50V)	1667	500	167	100	50 (Ω)
R_a (with touch voltage of 25V)	833	250	83	50	25 (Ω)

Shown below is a practical example of verification of the protection by RCD in a TT system according to the international Standard IEC 60364.

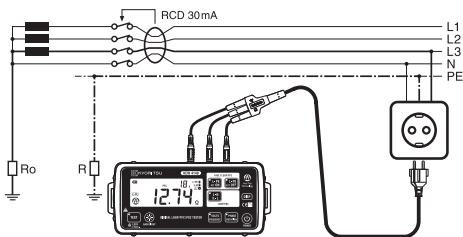

Fig7-2

For this example the max permissible value is 1667Ω (RCD = 30mA and contact voltage limit of 50 V). The instruments reads 12.74Ω , thus the condition $RA \leq 50/I_a$ is respected. However, considering that the RCD is essential for protection, it must be tested (Please refer to RCD TESTS section).

TN System

For TN systems the earth fault loop impedance is the sum of the following impedances.

- Impedance of the power transformer secondary winding.
- Impedance of the phase conductor from the power transformer to the location of the fault.
- Impedance of the protective conductor from the fault location to the power transformer.

The figure below shows (dotted line) the Fault loop impedance for TN systems.

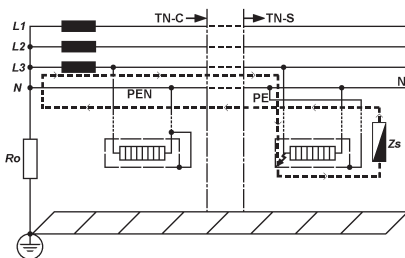

Fig.7-3

According to the International Standard IEC 60364, for TN system the characteristics of the protective device and the circuit impedance shall fulfill the following requirement:

$$Z_s \times I_a \leq U_o \quad \text{Where:}$$

Z_s is the Fault loop impedance in ohm.

U_o is the nominal voltage between phase to earth (typically 230V AC for both single phase and three phase circuits).

I_a is the current causing the automatic disconnection of the protective device within The maximum disconnecting times required by IEC 60364-41 that are:

- 400 ms for final circuits not exceeding 32A (at 230 / 400V AC)
- 5 s for distribution circuits and circuits over 32A (at 230 / 400V AC)

The compliance with the above rules shall be verified by:

- 1) Measurement of the fault loop impedance Z_s by Loop tester.
- 2) Verification of the characteristics and/or the effectiveness of the associated protective device. This verification shall be made:

- for circuit-breakers and fuses, by visual inspection (i.e. short time or instantaneous tripping setting for circuit-breakers, current rating and type for fuses);
- for RCDs, by visual inspection and test using RCD testers recommending that the disconnecting times mentioned above are met (Please see RCD TEST section).

For instance in a TN system with nominal mains voltage $U_0 = 230$ V protected by General purpose gG fuses or MCBs (Miniature Current Breakers) required by IEC 898 / EN 60898, the I_a and max Z_s values could be:

Rating (A)	Protection by gG fuses with U_0 of 230V				Protection by MCBs with U_0 of 230V (Disconnection time 0.4 and 5s)					
	Disconnection time 5s		Disconnection time 0.4s		Characteristic B		Characteristic C		Characteristic D	
	$I_a(A)$	$Z_s(\Omega)$	$I_a(A)$	$Z_s(\Omega)$	$I_a(A)$	$Z_s(\Omega)$	$I_a(A)$	$Z_s(\Omega)$	$I_a(A)$	$Z_s(\Omega)$
6	17	13.5	38	8.52	30	7.67	60	3.83	120	1.92
10	31	7.42	45	5.11	50	4.6	100	2.3	200	1.15
16	55	4.18	85	2.7	80	2.87	160	1.44	320	0.72
20	79	2.91	130	1.77	100	2.3	200	1.15	400	0.57
25	100	2.3	160	1.44	125	1.84	250	0.92	500	0.46
32	125	1.84	221	1.04	160	1.44	320	0.72	640	0.36
40	170	1.35	--	--	200	1.15	400	0.57	800	0.29
50	221	1.04	--	--	250	0.92	500	0.46	1000	0.23
63	280	0.82	--	--	315	0.73	630	0.36	1260	0.18
80	403	0.57	--	--						
100	548	0.42	--	--						

The most complete loop testers or Multifunction testers also have the Prospective Fault current measurement. In this case, Prospective Fault current measured with Instruments must be higher than the tabulated I_a of the protective device concerned.

Below is a practical example of verification of the protection by MCB in a TN system according to the international Standard IEC 60364.

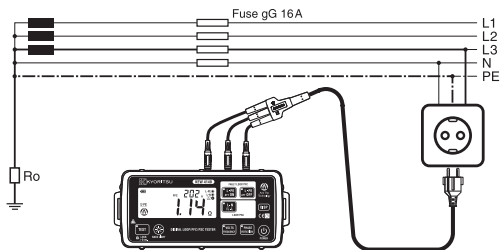

Fig.7-4

Max value of Z_s for this example is 1.44Ω (MCB 16A, characteristic C), the Instrument reads 1.14Ω (or 202 A on Fault current range) it means that the Condition $Z_s \times I_a \leq U_0$ is respected.

In fact the Z_s of 1.14Ω is less than 1.44Ω (or the Fault current of 202 A is more than I_a of 160A).

In other words, in case of fault between phase and earth, the wall socket tested in This example is protected because the MCB will trip within the disconnection time required.

7.2 Principles of the measurement of line impedance and PSC

The method for measuring Line – neutral impedance and line-line impedance is exactly the same as for earth fault loop impedance measurement with the exception that the measurement is carried out between line and neutral or line and line.

Prospective short circuit or fault current at any point within an electrical installation is the current that would flow in the circuit if no circuit protection operated and a complete (very low impedance) short circuit occurred. The value of this fault current is determined by the supply voltage and the impedance of the path taken by the fault current. Measurement of prospective short circuit current can be used to check that the protective devices within the system will operate within safety limits and in accordance with the safe design of the installation. The breaking current capacity of any installed protective device should be always higher than the prospective short circuit current.

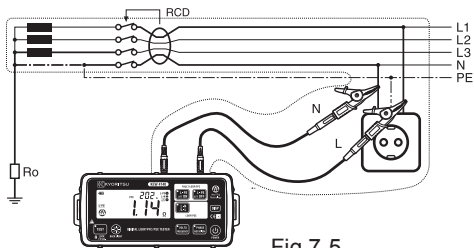

Fig.7-5

7.3. Operating instructions for LOOP and PSC/PFC

7.3.1 Initial Checks: to be carried out before any testing

1. Preparation

Always inspect your test instrument and lead accessories for abnormality or damage: If abnormal conditions exist DO NOT PROCEED WITH TESTING. Have the instrument checked by your distributor.

- (1) Operate the Power switch and turn on the instrument. (Press the Power switch for at least 1 sec.)

Press any of the following switches to select a function.

- L-PE ATT ON : for Line – Earth loop impedance tests (with ATT on)
 - L-PE ATT OFF : for Line – Earth loop impedance tests
 - L-N/L-L : for line - neutral or line – line loop impedance tests
- ATT enables a measurement without tripping the RCDs with the rated residual current of 30mA or more.

- (2) Insert the Test Lead into the instrument. (Fig.7-6)

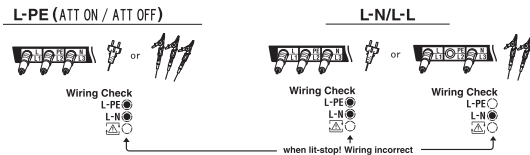

Fig.7-6

2. Wiring Check

After the connection, ensure that the symbols for Wiring check on the LCD are in the status indicated in Fig.7-6 before pressing the test switch.

If the status of the symbols for Wiring check differ from Fig.7-6

or symbol is indicated on the LCD, DO NOT PROCEED AS THERE IS INCORRECT WIRING. The cause of the fault must be investigated and rectified.

3. Voltage Measurement

When the instrument is first connected to the system, it will display the line-earth Voltage (L-PE ATT ON /ATT OFF) or line-neutral voltage (L-N/L-L) which is updated every 1s. If this voltage is not normal or as expected, DO NOT PROCEED.

7.3.2 Measurement of LOOP and PSC/PFC

a. Measurement at Mains Socket Outlet

Connect the mains test lead to the instrument. Insert the moulded plug of mains test lead into the socket to be tested. (see Fig.7-8)

Carry out the initial checks

Press the test switch. A beep will sound as the test is conducted and the value of Loop impedance will be displayed.

b. Measurement at the distribution board

Connect the distribution board lead Model 7246 to the instrument.

b-1.Measurement of Line – Earth Loop Impedance and PFC

Connect the green PE lead of the Model 7246 to the earth, the blue N lead to the neutral of the distribution board and the red L lead to one 'line' of the distribution board. (See Fig.7-9)

b-2.Measurement of Line – Neutral Loop Impedance and PSC

Connect the blue N lead of the Model 7246 to the neutral of the distribution board, the red L lead to one line of the distribution board. (See Fig.7-10)

b-3.Measurement of Line – Line Loop Impedance and PSC

Connect the blue N lead of the Model 7246 to the line of the distribution board, the red L lead to another line of the distribution board. (See Fig.7-11)

Carry out the initial checks

Press the test switch. A beep will sound as the test is conducted and the value of loop impedance will be displayed. When disconnecting from the distribution board, it is good practice to disconnect the line first.

7.3.3 Contents displayed on Sub Display

LOOP test results are displayed as illustrated below. Results displayed on the LCD are dependent on the selected function. Press the “DISP” Switch to toggle the test results displayed on the Sub Display.

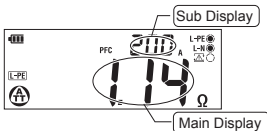

Fig.7-7

Contents displayed on Sub Display

Function	(A) Contents displayed on Sub Display after tests		(B)		(C)	
L-PE ATT ON	PFC Value	⇒	L-N LOOP Value	⇒	PSC Value	⇒ Back to (A)
L-PE ATT OFF	PFC Value	DISP Push	L-N LOOP Value	DISP Push	PSC Value	DISP Push Back to (A)
L-N/L-L	PSC Value		L-N or L-L Voltage		Back to (A)	

- If the display shows '>' then this usually means the value measured exceeds the range.
- Measurement in L-PE ATT ON function requires longer time than that is required for the other measurements (approx. 7 sec). When measuring a circuit with a large electrical noise, the 'Noise' Message is displayed on the LCD and the measurement time will be extended to 20 sec. If the 'NOISE' symbol is displayed on the LCD, it is recommended to make measurement in L-PE ATT OFF function. (RCDs may trip).
- If an impedance of 20Ω or more is measured between L-N during measurements in L-PE ATT ON function, “L-N>20Ω” is displayed on the LCD and no measurement can be made. In this case, select L-PE ATT OFF function and make measurement. RCD may trip when performing a test at L-PE ATT OFF function.
- When a large contact voltage exists in the circuit under test, “n-E Hv” is displayed on the LCD and no measurement can be made. In this case, select L-PE ATT OFF function and make measurement. RCD may trip when performing a test at L-PE ATT OFF function.
- If the symbol (🔥) appears, this means that the test resistor is too hot and the automatic cut out circuits have operated. Allow the instrument to cool down before proceeding. The overheat circuits protect the test resistor against heat damage.

- Measured result may be influenced depending on the phase angle of the distribution system when making measurement near a transformer and the result may lower than the actual impedance value. Errors in measured result are as follows.

System Phase Difference	Error (approx.)
10°	-1.5%
20°	-6%
30°	-13%

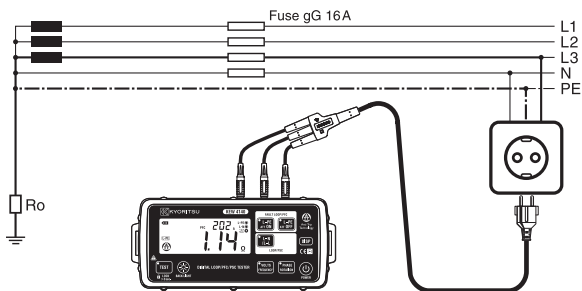

Fig.7-8 Connection for using Outlet

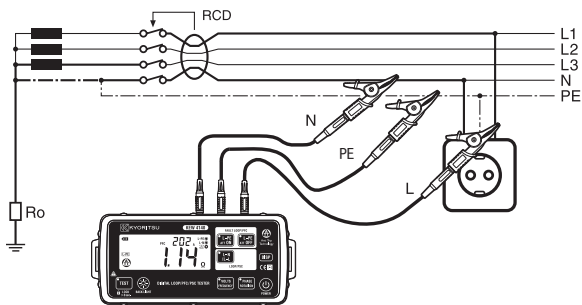

Fig.7-9 Connection for distribution

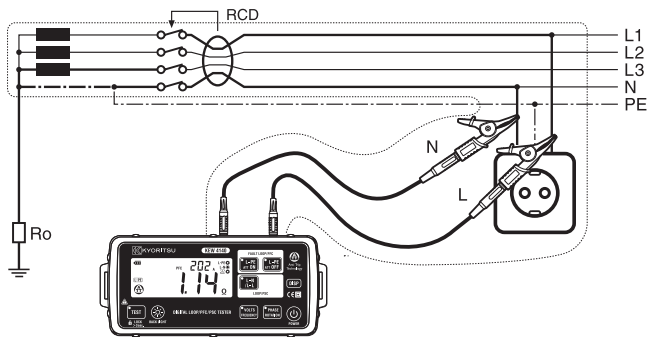

Fig.7-10 Connection for Line – Neutral measurement

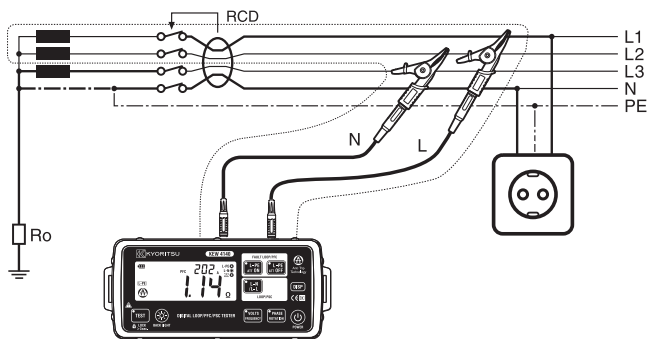

Fig.7-11 Connection for Line – Line measurement

8. Phase Rotation Tests

1. Operate the Power switch and turn on the instrument. Press the PHASE ROTATION function switch .
2. Insert the Test Leads into the instrument. (Fig.8-1)



Fig.8-1

3. Connect each test leads to a circuit. (Fig.8-2)

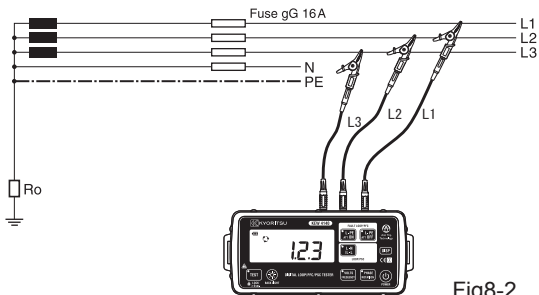

Fig8-2

4. Results are displayed as follows.



Correct phase sequence
Fig.8-3



Reversed phase sequence
Fig.8-4

- When a message “no” or “ --- ” is displayed, the circuit may not be a 3-phase system or a wrong connection may have been made. Check the circuit and the connection.
- Presence of Harmonics in measurement voltages, such as an inverter power supply, may influence the measured results.

9. Volts

1. Operate the Power switch and turn on the instrument. Press the VOLTS function switch .
2. Insert the Test Leads into the instrument. (Fig.9-1)



Fig.9-1

3. Voltage value and frequency will be displayed on the LCD when applying AC voltage.

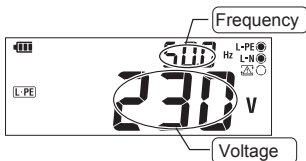

Fig.9-2

10. Back Light

Pressing the Back Light Switch selects Backlight ON / OFF. Backlight automatically turns off in 2 minutes after it turns on.

11. Auto-Test

The Test Switch is locked when the switch is pressed down for 3 sec. The red LED on the switch will flash .In this auto mode, when using distribution board lead Model 7246, tests are conducted by simply disconnecting and reconnecting the red phase prod of the Model 7246 avoiding the need to physically press the test button i.e. 'hands free'.

12. Battery Replacement

⚠ DANGER

- Never open the battery compartment cover while making measurement. To avoid possible electrical shock, disconnect the test probe before opening the cover for battery replacement.

⚠ CAUTION

- Install batteries in correct polarity as marked inside.
- Do not mix batteries of different types or new batteries with used ones.

When the display shows the low battery indication, , disconnect the test leads from the instrument. Remove the battery cover and the batteries. Replace with six (6) new 1.5V AA batteries, taking care to observe correct polarity. Replace the battery cover.

Battery type : six (6) 1.5V AA batteries

(Use of alkaline batteries (LR6) is recommended.)

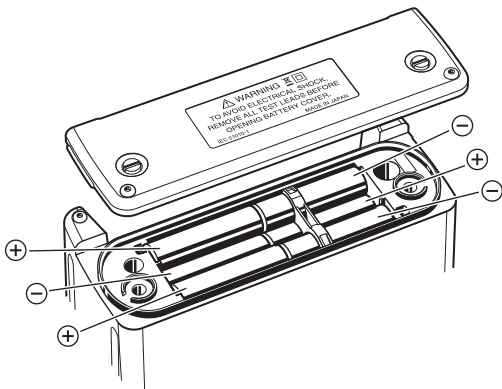

Fig.12-1

13. Servicing

If this tester should fail to operate correctly, return it to your distributor stating the exact nature of the fault. Before returning the instrument ensure that:-

1. The batteries are in good condition.

Please remember to give all the information possible concerning the nature of the fault, as this will mean that the instrument will be serviced and returned to you more quickly.

14. Case and Strap Assembly

14-1 How to fasten the Strap belt

- (1) Pass the Side Belt through the Buckle as shown in Fig.14-1. (2 pcs)

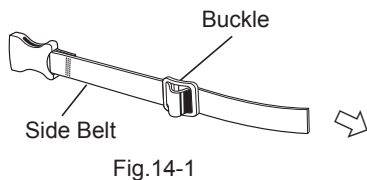

- (2) Attach the Side Belt to the instrument as shown in Fig.14-2. (both sides)

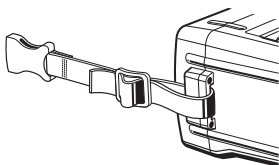

- (3) Attach the both ends of the Strap Belt to the Side Belt. (see Fig.14-3)

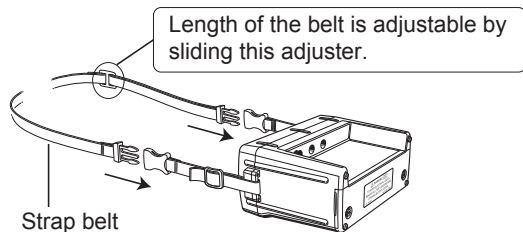

Fig.14-3

14-2 How to store in Soft Case

Follow the procedure (1) and (2) as illustrated below to store the instrument in the Soft Case.

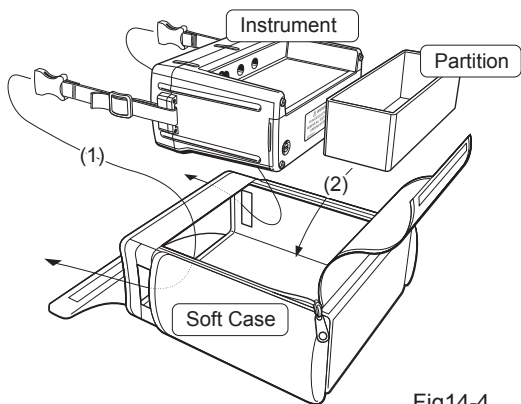

Fig14-4

- (1) Pass the Belt attached to the instrument through the slot on the Soft Case and store the instrument in the Soft Case.
- (2) Put a partition to be adjacent to the bottom face of the instrument.(Store the test leads in the partition.)

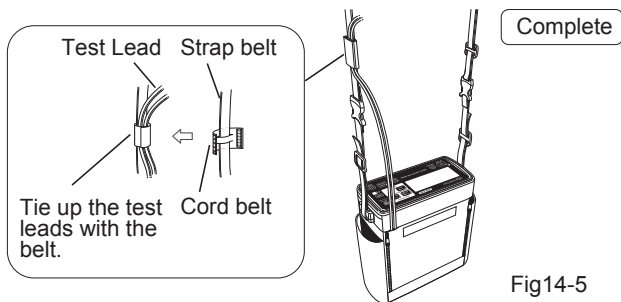

Fig14-5

MEMO

MEMO

DISTRIBUTOR

Kyoritsu reserves the rights to change specifications or designs described in this manual without notice and without obligations.